

RIGOL

用户手册

PCA1030/PCA2030/PCA1150 /PCA1500 电流探头

2022 年 5 月
RIGOL TECHNOLOGIES CO., LTD.

保证和声明

版权

© 2022 普源精电科技股份有限公司

商标信息

RIGOL 是普源精电科技股份有限公司的注册商标。

文档编号

UGE32001-1110

声明

- 本公司产品受中国及其它国家和地区的专利（包括已取得的和正在申请的专利）保护。
- 本公司保留改变规格及价格的权利。
- 本手册提供的信息取代以往出版的所有资料。
- 本手册提供的信息如有变更，恕不另行通知。
- 对于本手册可能包含的错误，或因手册所提供的信息及演绎的功能以及因使用本手册而导致的任何偶然或继发的损失，**RIGOL** 概不负责。
- 未经 **RIGOL** 事先书面许可，不得影印、复制或改编本手册的任何部分。

产品认证

RIGOL 认证本产品符合中国国家产品标准和行业产品标准及 ISO9001:2015 标准和 ISO14001:2015 标准，并进一步认证本产品符合其它国际标准组织成员的相关标准。

联系我们

如您在使用此产品或本手册的过程中有任何问题或需求，可与 **RIGOL** 联系：

电子邮箱：service@rigol.com

网址：www.rigol.com







一般安全概要

注意



本产品符合 IEC 61010 安全标准并在出厂前经过安全测试。但使用中的任何不当操作都可能会对操作人员造成伤害甚至危及生命安全，也会对设备造成损坏。因此，使用本产品之前，请确保理解本手册所述的指导说明和注意事项。

安全术语和符号

使用本产品之前，请仔细阅读如下安全注意事项。

	<p>产品上的  符号表示用户在使用相关功能之前须阅读手册中标有  符号的内容。</p> <p>手册中的  符号表示重要信息，用户须阅读该内容后才可使用产品。</p>
	<p>产品上的  符号表示仅可测量符合被测电路电压的绝缘导体。</p>

本手册中如下符号表示重要的注意事项或警告信息。

 危险	<p>表示不正确的操作将导致极端危害，对操作者造成严重伤害或死亡。</p>
 警告	<p>表示不正确的操作将导致重大危害，对操作者造成严重伤害或死亡。</p>
 注意	<p>表示不正确的操作可能对操作者造成伤害或损坏设备。</p>
备注	<p>表示与设备性能或正确操作相关的建议。</p>

目录

保证和声明	I
一般安全概要	II
安全术语和符号	II
安全注意事项	IV
服务	VII
电流探头简介	1
PCA1030/PCA2030 部件总览	2
PCA1150/PCA1500 部件总览	3
部件说明	3
电流探头使用方法	5
测量准备	5
消磁和零位调整	5
测量步骤	6
测量过程中需要注意的事项	10
规格	13
PCA1030/PCA2030	13
PCA1150	14
PCA1500	15
附录	16
附录 1 幅频特性	16
附录 2 最大输入电流与频率的关系	18
附录 3 输入阻抗（典型）	20

安全注意事项

危险

1. 请勿在裸导体附近测量，否则可能会引起短路或遭受电击。只可在对电路电压提供充分绝缘的导线处进行测量。
2. 测量含有高频成分的电流时，请参考**附录2 最大输入电流与频率的关系**。请勿测量超过额定值的电流。
3. 在高频或强磁环境下使用本产品可能导致产品出现异常发热，进而引起火灾、设备损坏或烧坏（见**规格**）。
4. 为避免电击或短路，请遵守如下注意事项。
 - 1) 首先将探头与波形测量仪器连接，然后再将该探头连接至被测的有源电线。
 - 2) 打开传感器时，请勿将被测导体短接。
 - 3) 测量时，请勿损坏仪器的绝缘层。
 - 4) 为避免电击，连接被测导体前，请确保其绝缘层完好无损。连接时，请注意不要损坏被测导体的绝缘层。
 - 5) 为避免发生火灾，损坏或烧坏被测对象和设备，测量高频电流或含有高频成分的电流时请关注如下内容：
 - ◇ 涡流损耗可能导致传感器头发热。
 - ◇ 介电加热可能导致电缆绝缘层或其它材料发热。
 - 6) 本探头只可连接至断路器的二次侧。此时，断路器可以避免因短路造成的危害。请勿将本探头连接至断路器的一次侧。此种情况下，短路时无限制的电流将引起严重事故。
 - 7) 对于与本探头连接的波形测量仪器或其它测量仪器，请确保遵守其所有操作注意事项。
 - 8) 当测量仪器的输入端口、机箱或其它输入端之间没有绝缘时，请注意以下几点：如下页图所示，如果信号连接到除本探头所连接的端口之外的其它输入端口上，请勿将该信号的接地端连接至任何非地电势，否则短路电流将从接地端流经电流探头，引起电气事故或损坏电流探头。

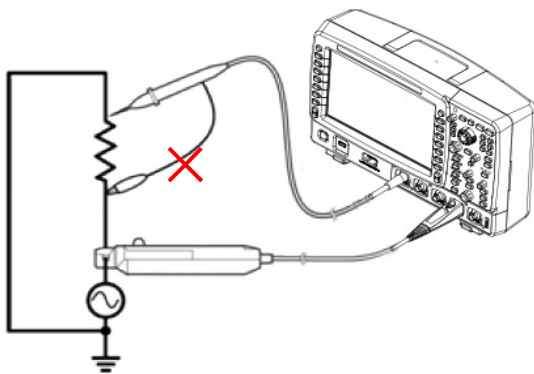

PCA1030/PCA2030

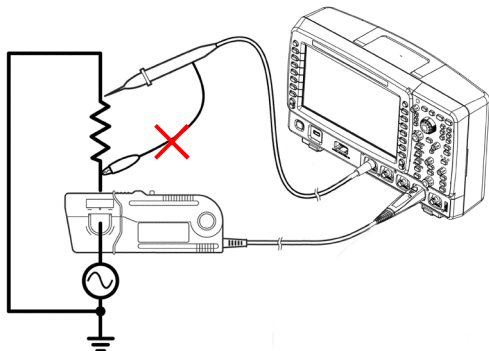

PCA1150/PCA1500

⚠警告

1. 请保持仪器干燥，并在测量时保持双手干燥，以免发生电击。
2. 当探头已连接被测导体时，请勿在波形测量仪器上执行消磁操作。否则，可能损坏电路或引起电气事故，进而造成人身伤亡。
3. 确保输入不要超过最大额定电流，以免由于过热而造成设备损坏、短路进而发生触电危险。
4. 测量带电线路时，为防止触电，请穿戴合适的防护装备，如绝缘手套、长靴和安全帽等。

 **注意**

1. 为防止损坏探头，在运输和搬运过程中请注意防震和碰撞，特别要避免跌落。
2. 本探头仅可在室内安装、操作，温度范围在0℃至40℃，相对湿度不大于80%。
3. 保存或使用仪器时，请勿将仪器放置在阳光直射、高温、潮湿或容易发生冷凝的地方，否则，仪器的绝缘性可能会降低从而影响其性能指标，甚至损坏仪器。
4. 本仪器并非完全防水或防尘，因此，请勿在潮湿或多尘的环境下使用，以免损坏仪器。
5. 电流传感器头为精密组合件，包含一个模制元件、铁氧体磁芯和霍尔效应元件。当环境温度突变、受到机械拉力或撞击时，电流传感器可能会损坏。因此使用时需格外小心。
6. 电流传感器头的齿合面经过了精细的研磨，使用仪器时应格外小心，以免划伤齿合面，影响探头的性能。
7. 当电流传感器头的齿合面上落有灰尘时，可能会影响测量结果的准确性。因此，用户需使用干净的软布轻轻擦拭以保持齿合面的清洁。
8. 当电流传感器头的齿合面上落有异物时，可能会产生共振噪音（参考后文关于**共振噪音**的介绍）并影响测量结果的准确性。因此，用户需使用干净的软布轻轻擦拭以保持齿合面的清洁。
9. 请不要过度弯折或拉扯电流传感器电缆，以免损坏电缆。
10. 请勿将静电或其它高压源应用于传感器。否则，可能损坏内部霍尔元件和电路。
11. 清洁探头时，请使用软布蘸取水或温和溶剂轻轻擦拭。请勿使用苯、酒精、丙酮、乙醚、酮、稀释剂或汽油等溶剂擦拭。否则，将造成产品变形或褪色。
12. 接通电源后，除非连接被测导体，其它时间请保持传感器闭合，否则，磁芯部分的齿合面可能会被划伤。

13. 不使用时请闭合传感器头，以免灰尘堆积到齿合面而影响其夹固性能。
14. 请勿踩踏或挤压电缆，以免损坏电缆的绝缘性。
15. 电缆应远离热源，否则其绝缘层将融化，从而造成导线裸露。

备注

当仪器周围存在强磁场（如变压器和高电流导体附近）或强电磁场（如无线电发射机附近）时，测量结果可能不正确。

服务

如需返厂维修，请将探头仔细包装以免其在运输过程中发生破损。包装时，请使用减震材料将探头稳固在包装内。同时，请附上产品故障的详细说明。因运输造成探头损坏，**RIGOL**公司恕不负责。

为了保证电流探头可提供指定精度的正确测量结果，请定期校准探头。如需校准，请与**RIGOL**联系。

电流探头简介

本电流探头直接与波形测量仪器的 BNC 输入连接器相连，通过传感器头连接被测导体，可轻松捕获电流波形。

主要特色：

- 高精度电流检测
- 简捷的电流测量
- 宽带频率特点
 - PCA1030: DC 至 50MHz
 - PCA2030: DC 至 100MHz
 - PCA1150: DC 至 10MHz
 - PCA1500: DC 至 2MHz
- PCA1030/PCA2030: 设计紧凑，允许测量小电流
- PCA1150/PCA1500: 导体直径较大允许测量大电流
- 简便的超量程输入保护功能
- 独创的薄膜霍尔效应元件

PCA1030/PCA2030 部件总览



图 1 PCA1030/PCA2030 部件示意图

关于上图中的部件 1 至 4，请参考**部件说明**。

备注

上图中的终端连接器集成电源，将输出连接器连接至波形测量仪器，当波形测量仪器上电时，为电流探头供电。

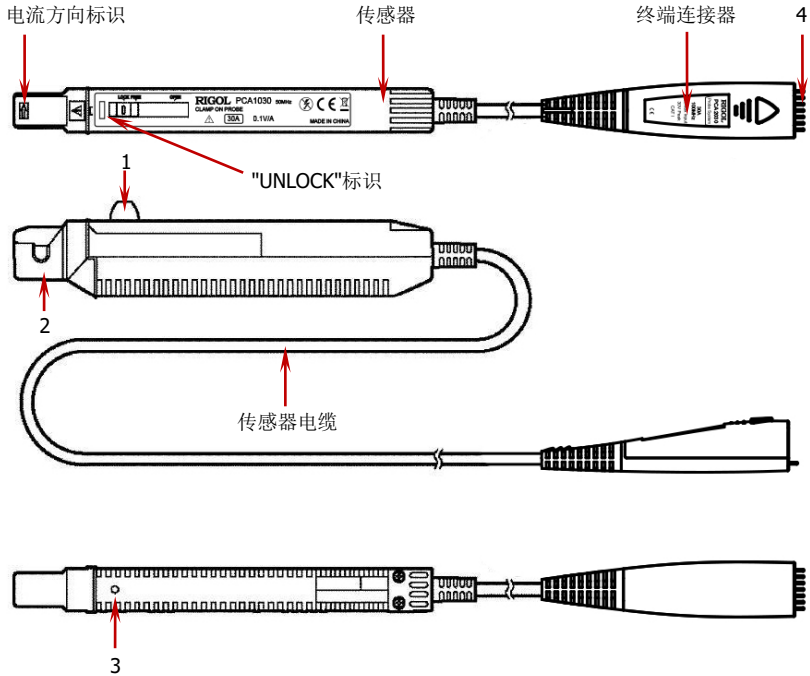
PCA1150/PCA1500 部件总览



图 2 PCA1150/PCA1500 部件示意图

关于上图中的部件（1、2、4），请参考**部件说明**。

备注

上图中的终端连接器集成电源，将输出连接器连接至波形测量仪器，当波形测量仪器上电时，为电流探头供电。

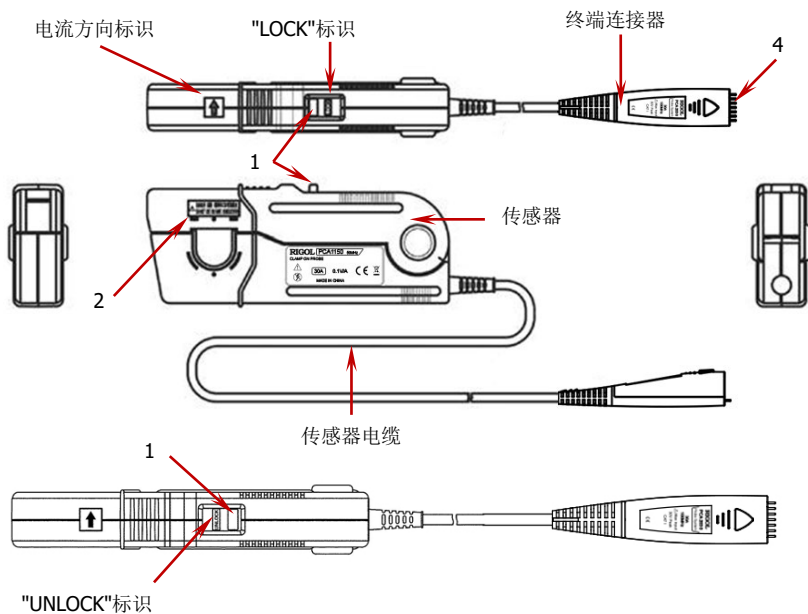
部件说明

1. 滑动开关

用于打开和锁紧电流传感器。测量被测导体时应锁紧电流传感器，以免发生危险。

对于 PCA1030/PCA2030，滑动开关的一侧标有 OPEN、FREE 和 LOCK 三种标识，电流传感器的开关状态与滑动开关所处的位置有关：

- ◇ 当滑动开关处于 OPEN 位置时，电流传感器完全打开，此时可将被测导体连接至电流传感器；
- ◇ 当滑动开关处于 FREE 位置时，电流传感器处于闭合状态但未锁紧；
- ◇ 当滑动开关处于 LOCK 位置时，电流传感器头处于锁紧状态，此时，UNLOCK 标识被遮挡。

对于 PCA1150/PCA1500，滑动开关上面标有 LOCK 和 UNLOCK 标识，当开关上面显示 LOCK 标识并且 UNLOCK 标识消失时，电流传感器处于锁紧状态。

2. 电流传感器头

用于连接被测导体以执行实际电流测量。电流传感器头为精密装置，包含一个模制元件、铁氧体磁芯和霍尔效应元件。当环境温度突变、受到机械拉力或撞击时，可能会损坏电流传感器，因此使用时需格外小心。

3. 粗调整整器（仅适用于 PCA1030/PCA2030）

仅当无法在波形测量仪器的零位调整范围内进行调节时使用。可以使用绝缘螺丝刀（如陶瓷螺丝刀）通过该调整器进行调节。

4. 输出连接器

被测导体的电流波形将以恒定的增益通过该连接器输出至波形测量仪器。该输出连接器可连接至波形测量仪器的 BNC 输入连接器。

备注

- 因电流探头输出阻抗为 25Ω（PCA1030/PCA2030）或 7Ω（PCA1150/PCA1500），因此，本电流探头只可与输入阻抗至少为 1 MΩ 的波形测量仪器相连接。若使用输入阻抗为 50Ω 的波形测量仪器进行测量，则会导致测量结果不准确。
- 若使用 BNC 转香蕉插头或其它类似连接器连接除 BNC 连接器之外的输入端口，请注意保证极性正确。

电流探头使用方法

使用电流探头执行测量之前，请仔细阅读**安全注意事项**一节。

测量准备

1. 准备一台波形测量仪器。
2. 将波形测量仪器连接至交流电源。
3. 将电流探头的输出连接器连接至波形测量仪器的输入端。

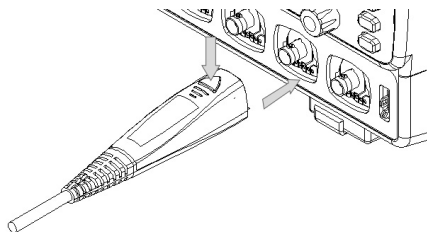

4. 打开波形测量仪器的开关，并检查电源指示灯是否点亮。
5. 打开电流探头后，请等待至少**30分钟**。刚接通电源时，由于预热等因素，将产生明显的零点漂移，因此，为保证测量的准确性，执行测量前，应将电流探头预热**30分钟**以上。

消磁和零位调整

1. 如果波形测量仪器的输入为地电平，应将其基线调整至零位。
2. 将波形测量仪器的输入耦合设置为直流。

注意

- 断开输出连接器与波形测量仪器的连接时，首先解除锁紧，然后将连接器拔出。未解除锁紧而直接拔出或拉扯电缆线可能损坏终端连接器。
- 若使用 BNC 转香蕉插头或其它类似连接器连接除 BNC 连接器之外的

输入端，请注意保证极性正确。

- 当电流探头的电流传感器连接被测导体时，请勿进行消磁操作，因为消磁操作会导致电流流入导体，可能会损坏被测电路的器件。

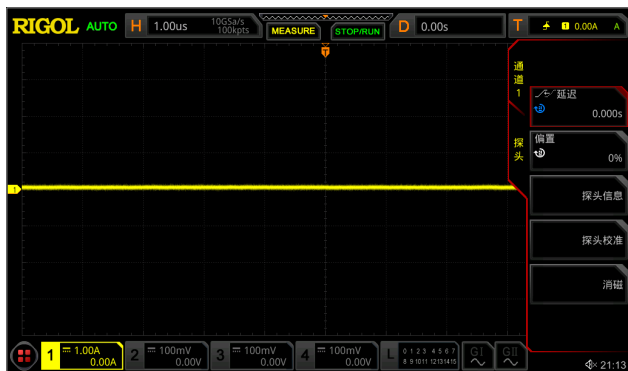

- 鉴于上述考虑，由于为电流探头供电将产生消磁波形，因此为电流探头供电前，请确保电流探头未连接被测导体。
3. 请确保电流传感器处于锁紧状态（对于 PCA1030/PCA2030，滑动开关应处于 LOCK 位置；对于 PCA1150/PCA1500，滑动开关上面显示 LOCK 标识且无 UNLOCK 标识显示）。
 4. 在波形测量仪器上执行消磁操作。
 5. 在波形测量仪器上执行零位调整操作，将基线调至零位。

备注

对于 PCA1030/PCA2030，当通过波形测量仪器的零位调整功能无法实现零位调整时，可以通过粗调整器将基线调整至波形测量仪器的零位调整功能可调节的范围内。

调整粗调整器时，请勿用力过大，否则，可能导致调整器脱落。请使用符合如下要求的一字螺丝刀：螺丝刀头由陶瓷等非导电物质制成，厚 0.4mm，宽 1.8mm，长度不小于 10mm。

测量步骤

1. 检查并确保测量系统安全且上述准备工作已就绪。

- 按照下图箭头所示方向拨动滑动开关打开电流传感器（对于 PCA1030/PCA2030，滑动开关处于 OPEN 位置；对于 PCA1150/PCA1500，滑动开关上面显示 UNLOCK 标识，LOCK 标识消失）。

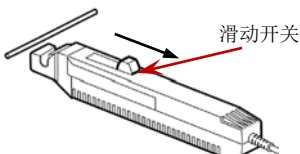

- 调整电流传感器，使其电流方向标识与待测导体中的电流方向一致，使用电流传感器连接待测导体，并使待测导体位于孔中心。
- 按照下图箭头所示方向拨动滑动开关将电流传感器锁紧（对于 PCA1030/PCA2030，滑动开关应处于 LOCK 位置；对于 PCA1150/PCA1500，拨动滑动开关直至上面显示 LOCK 标识，UNLOCK 标识消失）。

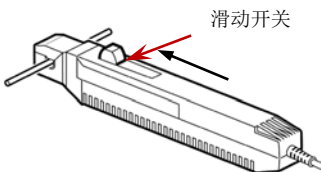

- 此时，您可以查看电流波形。PCA1030/PCA2030 的输出增益为 0.1V/A，PCA1150/PCA1500 的增益为 0.01V/A。您可以通过波形测量仪器的电压灵敏度计算出电流灵敏度。例如，对于 PCA1030，波形测量仪器的电压灵敏度为 10mV/div，则电流灵敏度为 $(10\text{mV/div})/(0.1\text{V/A})=100\text{mA/div}$ 。

备注

- 电流探头的电流消耗取决于被测电流。下图为输出电流与电流消耗之间的关系曲线：

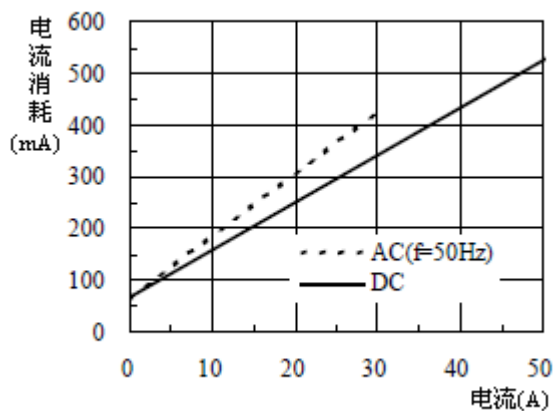
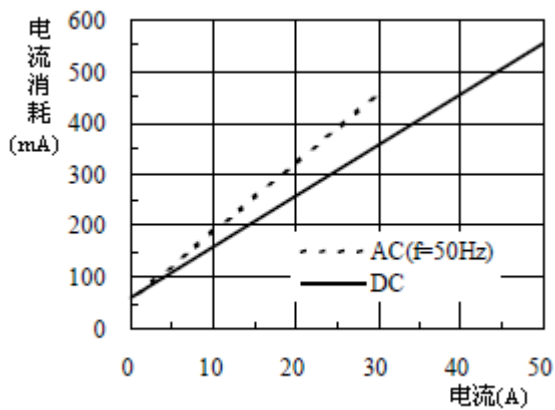

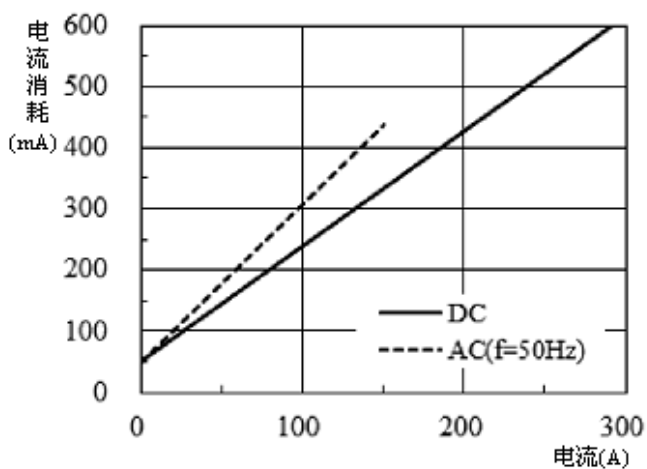

PCA1150

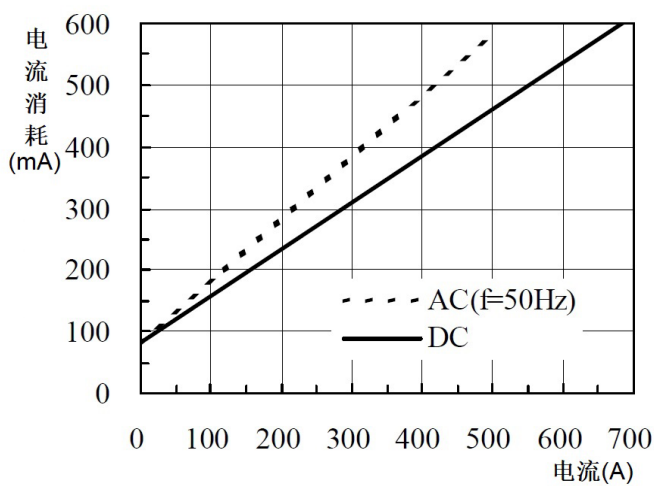

PCA1500

注：电流消耗为正负电流消耗代数之和。

测量过程中需要注意的事项

⚠注意

1. 最大连续输入范围是基于测量过程中仪器内部所产生的热量而定的。注意：输入电流不可超过该范围，否则可能损坏电流探头。
2. 参考**附录 2 最大输入电流与频率的关系**。最大额定电流为标准条件下正弦波输入时的推荐值。当环境温度增加或被测电流含有其它频率成分时将增加自发热。因此，即使电流探头工作在低于额定电流的条件下，也可能由于自发热而损坏。
3. 如果输入电流超出最大连续输入范围，可能导致仪器内部温度过高而启动内置的保护电路功能，该功能会阻碍正常的输出。此时，请立即断开电流传感器与被测导体的连接或将输入电流降低至 **0**，待电流传感器充分冷却后，方可重新进行操作。
4. 测量 **1kHz** 以上（含）的电流将导致电流传感器头温度上升。发生此现象是因为传感头的自发热。在这种情况下，内置的保护电路功能不会被激活。请注意避免事故发生，如灼伤、短路及设备损坏。
5. 即使输入电流未超出额定连续输入范围，但长时间的连续输入也会启动保护电路功能以避免电流传感器发热引起的设备损坏。
6. 当环境温度过高时，即使输入电流低于额定连续输入范围，也可能会启动内置的保护电路功能。
7. 如果输入电流多次超出额定最大连续输入范围而使保护电路反复启动，将会造成设备损坏。
8. 最大输入范围由**最大连续输入范围**确定，也由**最大峰值电流值**确定。请确保输入不大于最大连续输入有效值范围。
9. 由于周围导体中的电流可能会使电流传感器温度升高，因此，请勿将带有 **10kHz** 或更高频率电流的导体放在电流传感器头周围，以免损坏电流传感器，如下图所示。

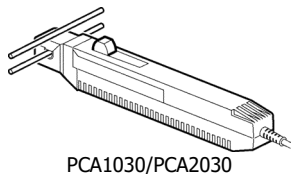

PCA1030/PCA2030

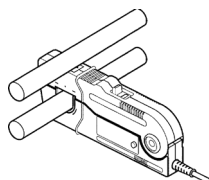

PCA1150/PCA1500

10. 请使用滑动开关打开电流传感器头。对于 PCA1030/PCA2030，传感头锁紧时，如果其上芯被强制打开，则有可能损坏滑动开关的内部结构。

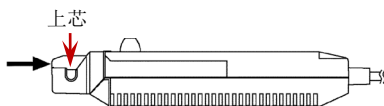

备注

1. 刚接通电源时，由于自发热，将产生明显的零点漂移，因此，为防止这种情况的发生，进行测量前，应将电流探头预热 30 分钟以上。
2. 执行连续测量时，请注意由于环境温度等因素而引起的零点漂移。
3. 在某些情况下，将输出连接器连接至通电的波形测量仪器时，可能会产生震荡，该情况不属于仪器故障，可通过开关传感器的卡钳消除震荡并使操作恢复正常。
4. 基于被测电流的幅值和频率，传感器头可能会产生共振噪音。消磁过程中也可能产生共振噪音。这不属于仪器故障。
5. 若电流传感器头的齿合面沾有异物，这将在电流传感器的上层和下层之间产生微小缝隙，这种情况下，电流传感器头将产生共振噪音。因此，请在测量之前使用本手册所述清洁方法清除齿合面上的所有异物。
6. 使用过程中，若共振噪音的音量增大，表示电流传感器的上层和下层之间的缝隙变大。因此，电流传感器的特性将改变。此时，建议您校准探头。
7. 在波形测量仪器上执行消磁操作，将从探头输出一个消磁波形。该波形可能并不以零电压线对称，该情况不属于仪器故障。
8. 请将被测导体连接至电流传感器的钳孔中心，否则，将影响测试结果。

9. 执行电流测量时，请确保传感器头已锁紧（对于 PCA1030/PCA2030，滑动开关应处于 LOCK 位置；对于 PCA1150/PCA1500，首先应该上下按压电流探头闭合电流传感器，然后拨动滑动开关直至上面显示 LOCK 标识，UNLOCK 标识消失）。若电流传感器没有完全闭合，将无法得到准确的测量结果。
10. 当仪器周围存在强磁场（如变压器和高电流导体附近）或强电磁场（如无线电发射机附近）时，测量结果可能不正确。
11. 频率较高时，共模噪声可能会影响电路高压端的测量。此情况下，降低波形测量仪器的频率范围或连接电路的低压端。

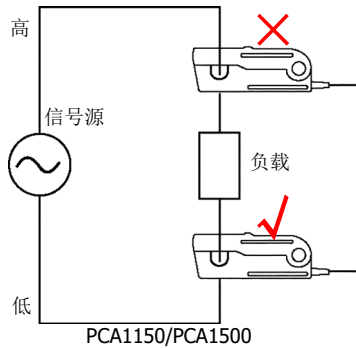
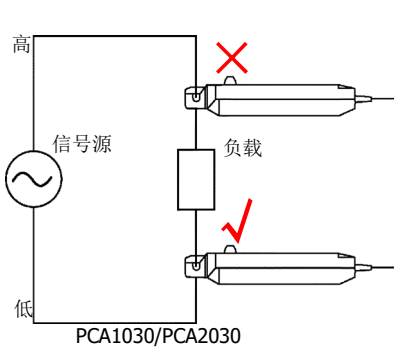

规格

当仪器在规定的操作温度（23℃±5℃）下连续运行 30 分钟以上时，以下指标可以得到保证。

PCA1030/PCA2030

带宽	PCA1030: DC 至 50MHz(-3dB), 参考附录 1 幅频特性(PCA1030) PCA2030: DC 至 100MHz(-3dB), 参考附录 1 幅频特性(PCA2030)
上升时间	PCA1030: ≤7ns PCA2030: ≤3.5ns
最大连续输入范围	30Arms, 参考附录 2 最大输入电流与频率的关系 (PCA1030/PCA2030)
最大峰值电流值	50A 峰值, 非连续
增益	0.1V/A
幅度精度	±1.0%rdg±1mV, ≤30Arms ±2.0%rdg, ≤50A 峰值 (DC, 45Hz 至 66Hz, 输入在最大连续输入范围内)
噪声	≤2.5mArms (带宽为 20MHz 的波形测量仪器)
输入阻抗	参考附录 3 输入阻抗 (典型) (PCA1030/PCA2030)
灵敏度的温度系数	≤±2% (温度范围 0℃ 至 40℃, 输入 50Hz, 30Arms)
最大额定功率	8.5VA
操作温度和湿度范围	0℃ 至 40℃, 相对湿度≤80% (无凝结)
储存温度和湿度范围	-10℃ 至 50℃, 相对湿度≤80% (无凝结)
应用场所	室内, 海拔≤2000m, 污染等级 2
外部磁场影响	PCA1030: ≤20mA (DC 和 60Hz, 400A/m 磁场) PCA2030: ≤5mA (DC 和 60Hz, 400A/m 磁场)
可测量导体的直径	5mm
可测量导体	绝缘导体
精度保证期	1 年 (开/关次数最多可达 1 万次)
电缆长度	传感器电缆: 约 1.5m
外部尺寸	传感器: 约 175W×18H×40Dmm (不包括突出部分) 终端连接器: 约 27H×55W×18Dmm
重量	PCA1030: 约 230g PCA2030: 约 240g

RIGOL

附件	用户手册，探头包
安规	EN61010
EMC	EN61326

PCA1150

带宽	DC 至 10MHz(-3dB)，参考附录 1 幅频特性 (PCA1150)
上升时间	≤35ns
最大连续输入范围	150A，参考附录 2 最大输入电流与频率的关系 (PCA1150)
最大峰值电流值	300A 峰值，非连续 500A 峰值，脉宽≤30μs
增益	0.01V/A
幅度精度	±1.0%rdg±1mV，≤150A ±2.0%rdg，150A 至 300A 峰值 (DC, 45Hz 至 66Hz)
噪声	≤25mArms (带宽为 20MHz 的波形测量仪器)
输入阻抗	参考附录 3 输入阻抗 (典型) (PCA1150)
灵敏度的温度系数	≤±2% (温度范围 0℃至 40℃，输入 55Hz，150A)
最大额定功率	8.5VA
操作温度和湿度范围	0℃至 40℃，相对湿度≤80% (无凝结)
储存温度和湿度范围	-10℃至 50℃，相对湿度≤80% (无凝结)
应用场所	室内，海拔≤2000m，污染等级 2
精度保证期	1 年 (开/关次数最多可达 1 万次)
外部磁场影响	≤150mA (DC 或 60Hz，400A/m 磁场)
可测量导体直径	20mm
可测量导体	绝缘导体
电缆长度	传感器电缆：约 2m
外部尺寸	传感器：约 176W X 69H X 27Dmm 终端连接器：约 27H X 55W X 18Dmm
重量	约 500g
附件	用户手册，探头包
安规	EN61010
EMC	EN61326

PCA1500

带宽	DC 至 2MHz(-3dB), 参考附录 1 幅频特性 (PCA1500)
上升时间	≤175ns
最大连续输入范围	500Arms, 参考附录 2 最大输入电流与频率的关系 (PCA1500)
最大峰值电流值	700A 峰值, 非连续
增益	0.01V/A
幅度精度	±1.0%rdg±5mV, ≤500Arms ±2.0%rdg, ≤700A 峰值 (DC, 45Hz 至 66Hz)
噪声	≤25mArms (带宽为 20MHz 的波形测量仪器)
输入阻抗	参考附录 3 输入阻抗 (典型) (PCA1500)
灵敏度的温度系数	≤±2%(温度范围 0℃至 40℃, 输入 50Hz, 500Arms)
最大额定功率	7.2VA (在最大连续输入范围内)
操作温度和湿度范围	0℃至 40℃, 相对湿度≤80% (无凝结)
储存温度和湿度范围	-10℃至 50℃, 相对湿度≤80% (无凝结)
应用场所	室内, 海拔≤2000m, 污染等级 2
精度保证期	1 年 (开/关次数最多可达 1 万次)
外部磁场影响	≤800mA (DC 或 60Hz, 400A/m 磁场)
可测量导体直径	20mm
可测量导体	绝缘导体
电缆长度	传感器电缆: 约 2m
外部尺寸	传感器: 约 176W X 69H X 27Dmm 终端连接器: 约 27H X 55W X 18Dmm
重量	约 520g
附件	用户手册, 探头包
安规	EN61010
EMC	EN61326

附录

附录 1 幅频特性

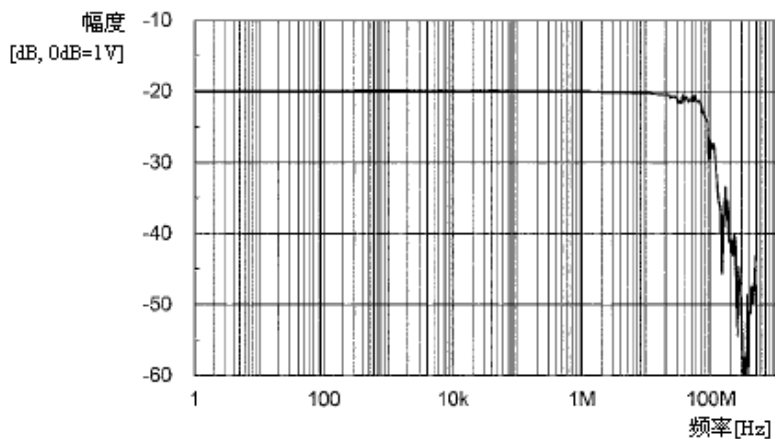

PCA1030

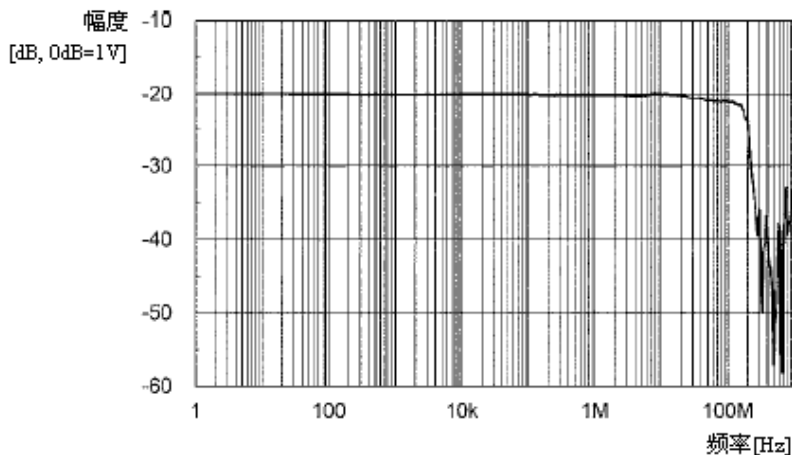

PCA2030

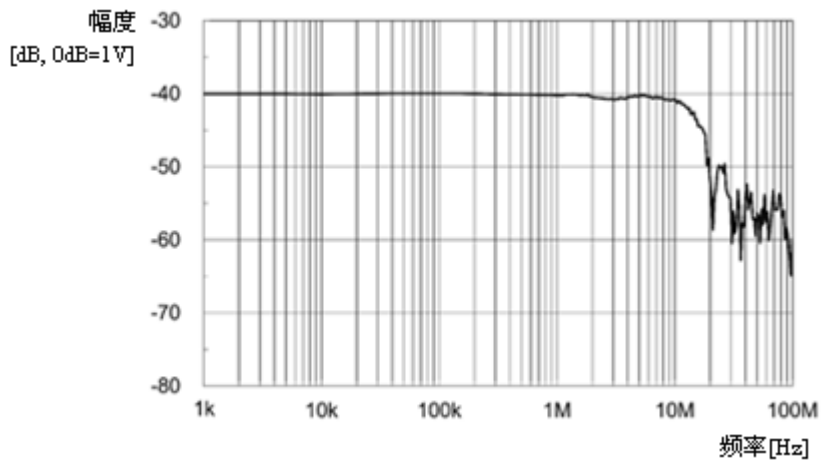
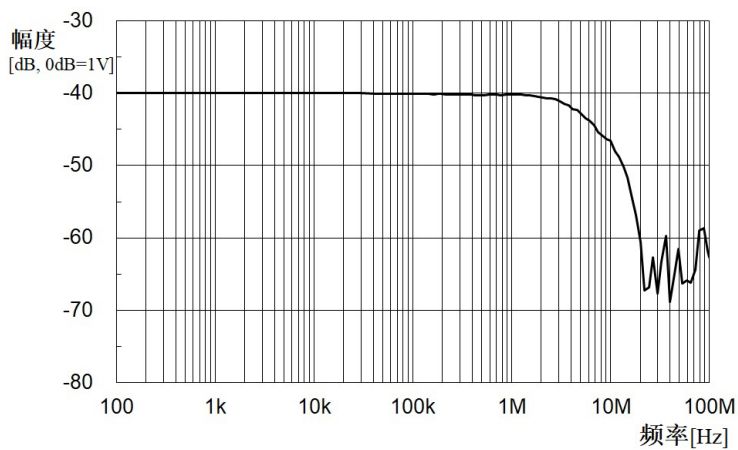
**PCA1150****PCA1500**

附录 2 最大输入电流与频率的关系

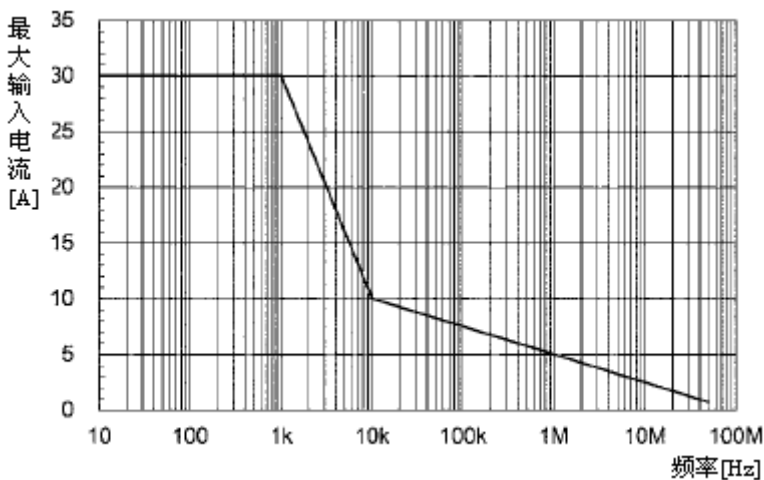

PCA1030

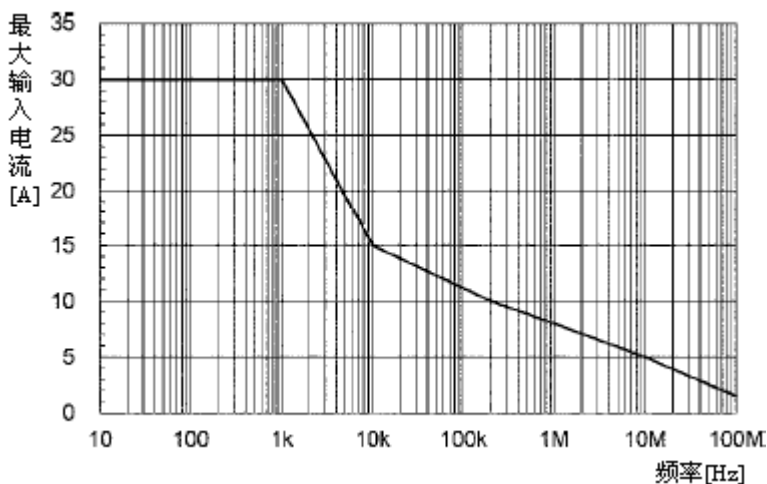

PCA2030

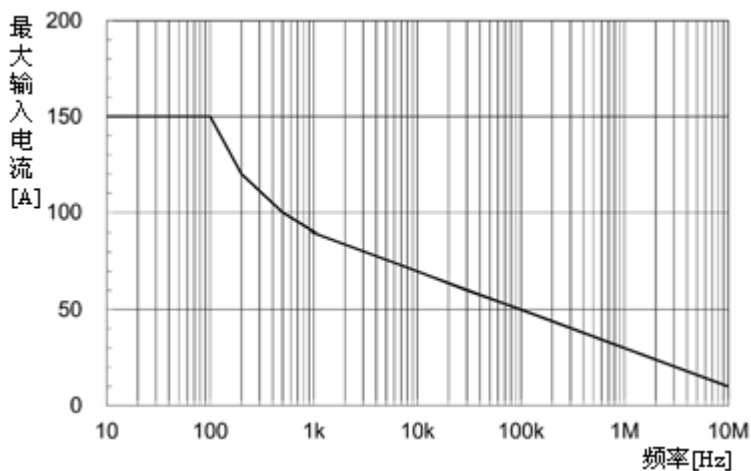
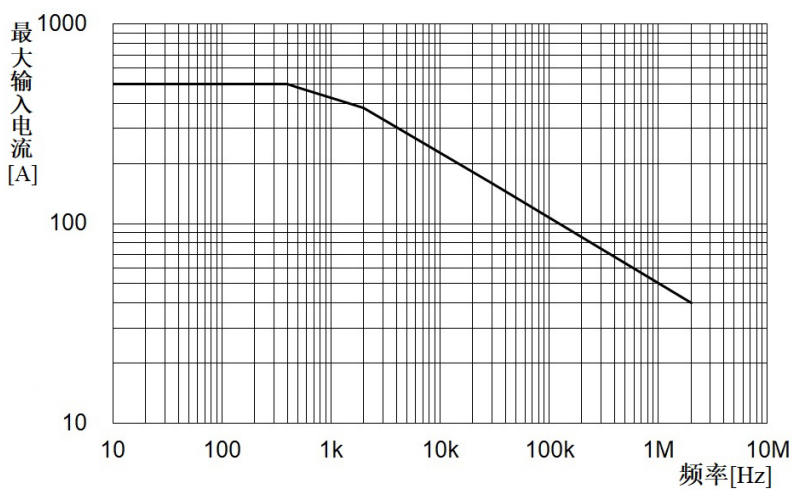
**PCA1150****PCA1500**

附录 3 输入阻抗 (典型)

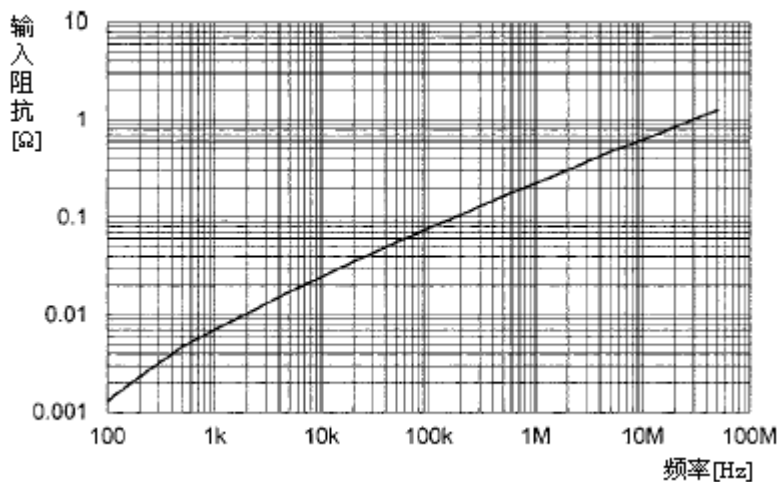

PCA1030

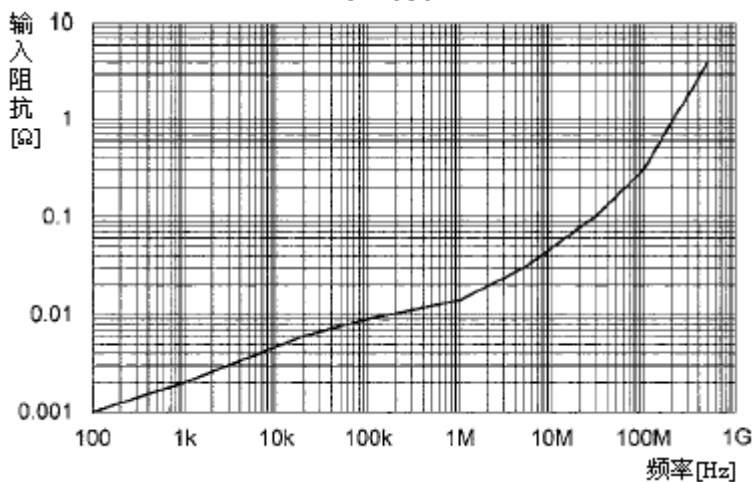

PCA2030

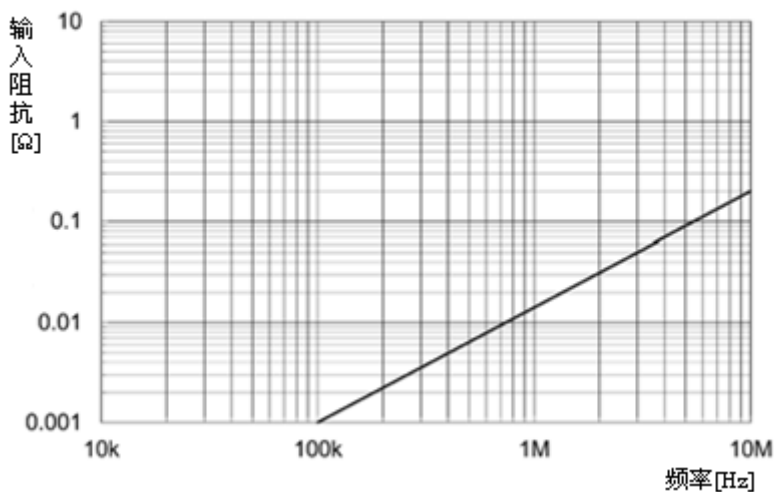
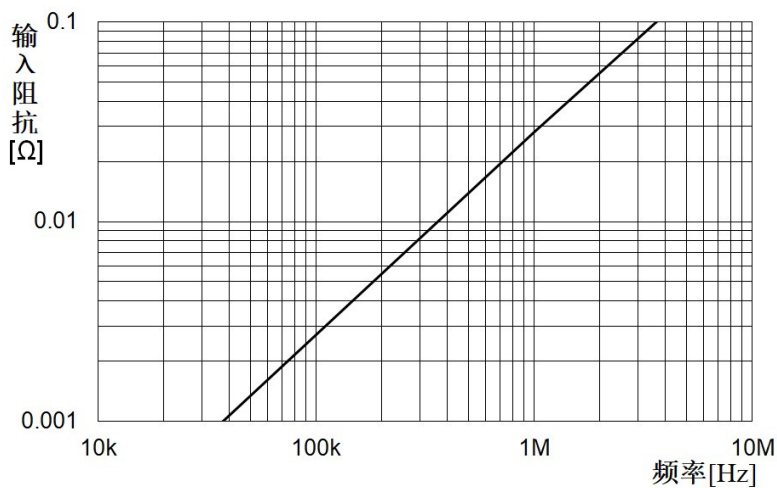
**PCA1150****PCA1500**

RIGOL

User Guide

PCA1030/PCA2030/PCA1150 /PCA1500 Current Probe

May. 2022
RIGOL TECHNOLOGIES CO., LTD.

Guaranty and Declaration

Copyright

© 2022 **RIGOL** TECHNOLOGIES CO., LTD. All Rights Reserved.

Trademark Information

RIGOL is the trademark of **RIGOL** TECHNOLOGIES CO., LTD.

Publication Number

UGE32101-1110

Notices

- **RIGOL** products are covered by P.R.C. and foreign patents, issued and pending.
- **RIGOL** reserves the right to modify or change parts of or all the specifications and pricing policies at the company's sole decision.
- Information in this publication replaces all previously released materials.
- Information in this publication is subject to change without notice.
- **RIGOL** shall not be liable for either incidental or consequential losses in connection with the furnishing, use, or performance of this manual, as well as any information contained.
- Any part of this document is forbidden to be copied, photocopied, or rearranged without prior written approval of **RIGOL**.

Product Certification

RIGOL guarantees that this product conforms to the national and industrial standards in China as well as the ISO9001:2015 standard and the ISO14001:2015 standard. Other international standard conformance certifications are in progress.

Contact Us

If you have any problem or requirement when using our products or this manual, please contact **RIGOL**.

E-mail: service@rigol.com

Website: www.rigol.com







General Safety Summary

CAUTION



This device is designed to comply with IEC 61010 Safety Standards, and has been thoroughly tested for safety prior to shipment. However, mishandling during use could result in injury or death, as well as damage to the device. Ensure that you have understood the instructions and precautions in the manual before use.

Safety Terms and Symbols

Before using the device, read the following safety notes carefully.

	<p>The  symbol printed on the device indicates that the user should refer to a corresponding topic in the manual (marked with the  symbol) before using the relevant function.</p> <p>In the manual, the  symbol indicates particularly important information that the user should read before using the device.</p>
	<p>The  symbol printed on the device indicates that only insulated conductors suitable to the voltage of the circuit under test can be measured.</p>

The following symbols in this manual indicate the important cautions and warnings.

 DANGER	<p>Indicates that incorrect operation presents an extreme hazard that could result in serious injury or death to the user.</p>
 WARNING	<p>Indicates that incorrect operation presents a significant hazard that could result in serious injury or death to the user.</p>
 CAUTION	<p>Indicates that incorrect operation presents a possibility of injury to the user or damage to the device.</p>
NOTE	<p>Indicates suggestions related to the performance of the device or correct operation.</p>

Contents

Guaranty and Declaration	I
General Safety Summary	II
Safety Terms and Symbols.....	II
Safety Precautions	IV
Service	VIII
Current Probe Overview	1
PCA1030/PCA2030 Parts Overview	2
PCA1150/PCA1500 Parts Overview	3
Parts Introductions	4
To Use the Current Probe.....	5
Preparations for Measurement	5
Demagnetizing and Zero Adjustment	6
Measurement Procedure.....	7
Precautions for Measurement.....	10
Specifications	14
PCA1030/PCA2030.....	14
PCA1150.....	15
PCA1500.....	16
Appendix.....	18
Appendix 1 Amplitude-Frequency Characteristics	18
Appendix 2 Relation between Max Input Current and Frequency	20
Appendix 3 Input Impedance (Typical)	22

Safety Precautions

DANGER

1. Do not measure around a bare conductor. Doing so may result in short-circuit or electric shock. Take measurements at a location on an insulated wire where there is sufficient insulation for the circuit voltage.
2. Refer to **Appendix 2 Relation between Max Input Current and Frequency** when measuring current that includes a high-frequency component. Never measure any current that exceeds the rated current.
3. Using the device in high-frequency or strong magnetic field may cause the device to become abnormally hot, resulting in fire, equipment damage, or burns (see **Specifications**).
4. Observe the following to avoid electric shock and short circuit.
 - 1) Connect the probe to the waveform measurement instrument first, and then connect the probe to the active cable to be measured.
 - 2) When the sensor is opened, do not short circuit the conductor being measured.
 - 3) Be careful to avoid damaging the insulation surface while taking measurements.
 - 4) Before clamping the conductor being measured, make sure that the insulation on the conductor is undamaged. Also, take care not to damage the insulation when clamping the conductor. Any damage to the insulation could cause an electric shock.
 - 5) To prevent fire, burns, or damage of the DUT, pay attention to the following items when measuring high-frequency current or current that has high-frequency components:
 - ◇ Eddy current loss may cause heating of the sensor head.
 - ◇ Dielectric heating may cause heating of cord insulation and other materials.
 - 6) This device should only be connected to the secondary side of a breaker, so the breaker can prevent an accident if a short circuit occurs. Connections should never be made to the primary side of a breaker, because unrestricted current flow could cause a serious accident if a short circuit occurs.
 - 7) Be sure to observe all operating precautions for the waveform measurement instrument and other measurement instruments to which this device is connected.
 - 8) When using a measurement instrument that does not provide

isolation between its input terminals, chassis, or other input terminals, please pay attention to the following points. As shown in the following figure, if a signal is applied to an input terminal other than that to which this device is connected, do not connect the ground terminal of the signal to any non-ground potential. Otherwise, short-circuit current will flow through the current probe from the ground terminal, which could cause an electrical accident or damage.

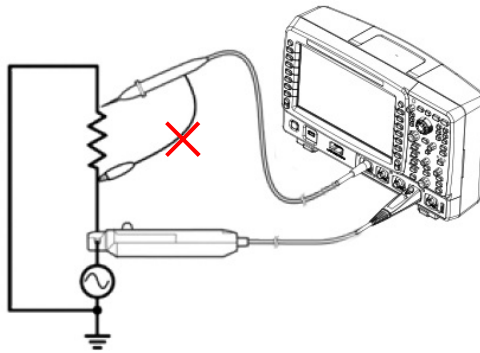

PCA1030/PCA2030

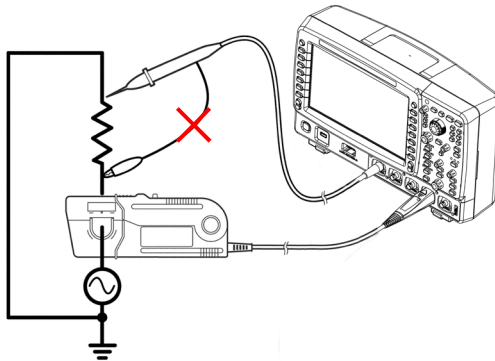

PCA1150/PCA1500

 WARNING

1. Keep the device dry, and do not take measurements with wet hands. This may cause an electric shock.
2. Do not perform demagnetization operation on the waveform measurement instrument while the conductor being measured is clamped onto the probe. Doing so could damage the circuitry or cause an accident that might result in injury or death.
3. Ensure that the input does not exceed the maximum rated current to avoid device damage, short-circuiting and electric shock resulting from overheating.
4. To avoid electric shock when measuring live lines, wear appropriate protective gear, such as insulated rubber gloves, boots and a safety helmet.

 CAUTION

1. To avoid damage to the device, protect it from vibration or shock during transport and handling, and be especially careful to avoid falling.
2. This probe should be installed and operated indoors only, at the ambient temperature between 0°C and 40°C, in the humidity of 80%RH or less.
3. Do not store or use the device in a place where it could be exposed to direct sunlight, high temperature, humidity, or condensation. Under such conditions, the device may be damaged and insulation may deteriorate so that it no longer meets specifications.
4. This device is not designed to be entirely water-proof or dust-proof. To avoid damage, do not use it in a wet or dusty environment.
5. The sensor head is a precision assembly which includes a molded component, a ferrite core, and a Hall effect element. It may be damaged if subjected to sudden changes in ambient temperature, or mechanical strain or shock, and therefore great care should be exercised in handling it.
6. The gear mating surface of the sensor head are precision ground, and should be treated with care. If the surface is scratched, performance may

be impaired.

7. Measurements are degraded by dirt on the gear mating surface of the sensor head, so keep the surface clean with a soft cloth.
8. Foreign substances such as dust on the contact surface of the sensor head can cause resonant sound (refer to the introduction about **resonant sound** in the later section) and degrade measurement, so it should be cleaned with a soft cloth.
9. Do not bend or pull the cables to avoid damaging them.
10. Do not apply a static electricity or other source of high voltage to the sensor. Doing so may damage its internal Hall elements and circuitry.
11. To clean the device, wipe it gently with a soft cloth moistened with water or mild detergent. Never use solvents such as benzene, alcohol, acetone, ether, ketones, thinners or gasoline, as they can deform and discolor the case.
12. When the power is on, keep the sensor closed, except when clamping it onto the conductor to be measured. Otherwise, the gear mating surface of the magnetic core section can be scratched when the sensor is open.
13. Keep the sensor head closed when not in use, to avoid accumulating dust or dirt on the gear mating surface, which could affect its clamp performance.
14. Avoid stepping on or pinching the cable, which could damage the cable insulation.
15. Keep the cables away from heat sources, as bare conductors could be exposed if the insulation melts.

NOTE

Correct measurement may be impossible in the presence of strong magnetic fields, such as near transformers and high-current conductors, or in the presence of strong electromagnetic fields such as near radio transmitters.

Service

When sending the device for repair, pack carefully to prevent damage in transit. Package the device with the cushioning materials to avoid causing damage to the probe. Be sure to attach the detailed failure descriptions about the product. **RIGOL** shall not be responsible for any damage of the probe that occurs during shipment.

A regular calibration is necessary in order to ensure that the current probe can provide correct measurement results with expected accuracy. If you need to calibrate the current probe, contact **RIGOL**.

Current Probe Overview

This device can be directly connected to a BNC input connector of a waveform measurement instrument. Once being clamped on a conductor to be measured through the sensor head, it can capture the current waveform easily.

Main Features:

- ◆ Highly accurate current detection
- ◆ Easy current measurement
- ◆ Broadband frequency characteristics
 - PCA1030: DC to 50 MHz
 - PCA2030: DC to 100 MHz
 - PCA1150: DC to 10 MHz
 - PCA1500: DC to 2 MHz
- ◆ PCA1030/PCA2030: Compact design, available to measure low current level
- ◆ PCA1150/PCA1500: Large diameter allows high-current measurements
- ◆ Easy protect function at excessive input
- ◆ Unique thin film Hall effect element

PCA1030/PCA2030 Parts Overview

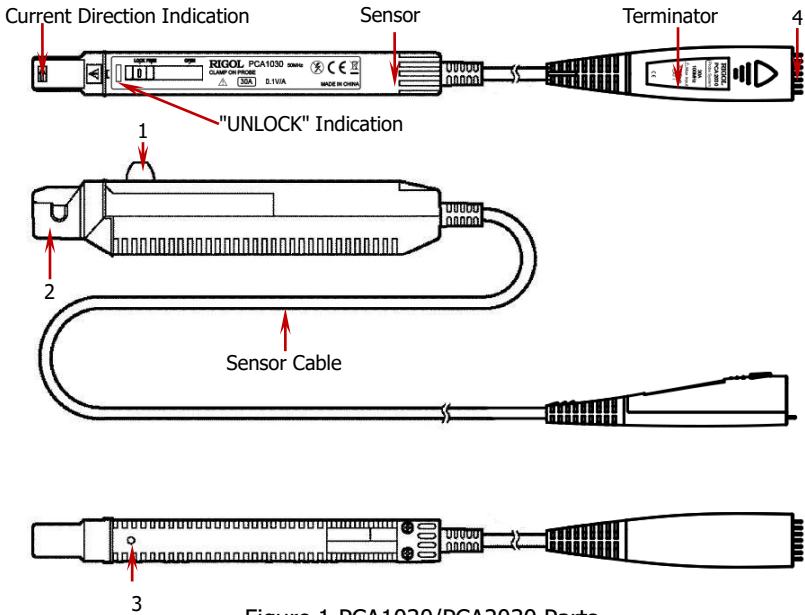

Figure 1 PCA1030/PCA2030 Parts

For the parts from 1 to 4 noted in the above figure, please refer to **Parts Introductions**.

NOTE

In the above figure, the Terminator is connected to the waveform measurement instrument via the output connector. The Terminator will provide power to the current probe when the waveform measurement instrument is powered on.

PCA1150/PCA1500 Parts Overview

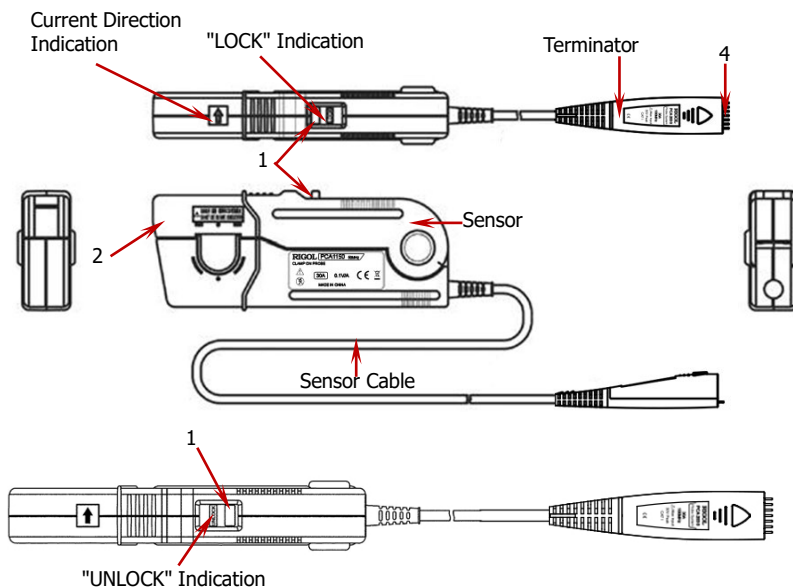

Figure 2 PCA1150/PCA1500 Parts

For the parts (1, 2, 4) noted in the above figure, please refer to **Parts Introductions**.

NOTE

In the above figure, the Terminator is connected to the waveform measurement instrument via the output connector. The Terminator will provide power to the current probe when the waveform measurement instrument is powered on.

Parts Introductions

1. Opening lever

It is used to open and lock the current sensor. You are recommended to lock the current sensor when measuring the conductor to avoid danger. For PCA1030/PCA2030, there are OPEN, FREE and LOCK indications on one side of the opening lever. The on/off status of the current sensor is related to the position of the opening lever.

- ✧ When the opening lever is in the OPEN position, the current sensor is open and at this point, the conductor to be measured can be connected to the current sensor;
- ✧ When the opening lever is in the FREE position, the current sensor is closed but not locked;
- ✧ When the opening lever is in the LOCK position, the current sensor is locked and at this point, the UNLOCK indication is covered (cannot be seen).

For PCA1150/PCA1500, there are LOCK and UNLOCK indications on the opening lever. The current sensor is locked when the LOCK indication is displayed on the opening lever (the UNLOCK indication disappears).

2. Sensor head

It is used to clamp the conductor under measurement to carry out the actual current measurement. It is a precision assembly that includes a molded component, a ferrite core, and a Hall effect element. It may be damaged if subjected to sudden changes in ambient temperature, or mechanical strain or shock, and therefore great care should be exercised in handling it.

3. Coarse adjustment trimmer (Only for PCA1030/PCA2030)

Use this only when the adjustment is outside the zero adjustment range of the waveform measurement instrument. Use a nonconductive screwdriver (e.g. ceramic driver) for adjustment on this coarse adjustment trimmer.

4. Output connector

The current waveform of the conductor under measurement is output at a constant gain via this connector to the waveform measurement instrument. This connector can be connected to the BNC input connector of the waveform measurement instrument.

NOTE

- Since the output impedance of the current probe is 25 Ω (PCA1030/PCA2030) or 7 Ω (PCA1150/PCA1500), the current probe must be connected to a waveform measurement instrument that has

an input impedance of at least 1 M Ω . Accurate measurement is not possible with waveform measurement instrument that has an input impedance of 50 Ω .

- If using BNC-banana plug adapters or similar connectors to connect to input terminals other than BNC connectors, make sure the polarity is correct in connection.

To Use the Current Probe

Before using the current probe, make sure to refer to **Safety Precautions**.

Preparations for Measurement

1. Prepare a set of waveform measurement instrument.
2. Connect the waveform measurement instrument to the AC power source.
3. Connect the output connector of the current probe to the input terminal of the waveform measurement instrument.

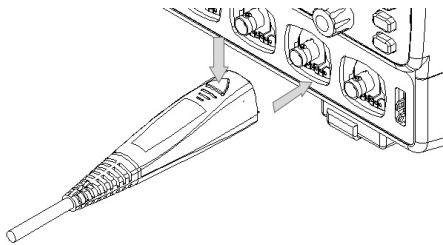

4. Power on the waveform measurement instrument, and check whether the front panel power indicator lights up.
5. Turn on the current probe and wait at least 30 minutes. Immediately after it is powered on, zero drift occurs obviously due to the warm-up and other factors. To ensure the accurate measurement, wait for at least a 30-minute warm-up after turning on the current probe before performing the measurement.

Demagnetizing and Zero Adjustment

1. With the waveform measurement instrument input at ground, adjust the trace to the zero position.
2. Set the input coupling of the waveform measurement instrument to DC.

⚠ CAUTION

- When disconnecting the output connector from the waveform measurement instrument, be sure to release the lock before pulling out the connector. Forcibly pulling out the connector without releasing the lock or pulling the cable can damage the terminator.
- If using BNC-banana plug adapters or similar connectors to connect to input terminals other than BNC connectors, make sure the polarity is correct in connection.
- Do not demagnetize while the sensor of the current probe is clamping a conductor to be measured. Demagnetizing causes current to flow into the conductor, which may damage components of the circuit to be measured.

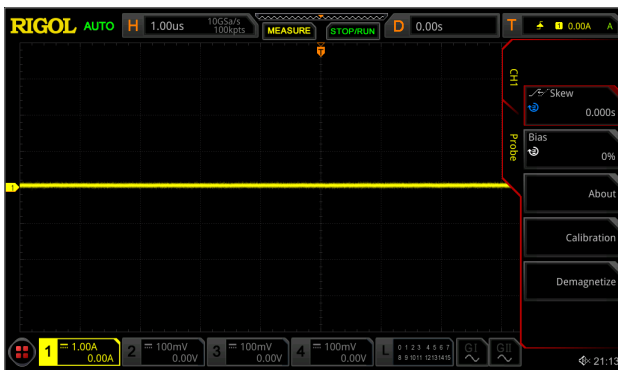

- With the above considerations, as the demagnetized waveform will be generated when the current probe is energized, ensure that no conductor being measured is clamped to the current probe before providing power to the current probe.
3. Make sure the current sensor is locked (for PCA1030/PCA2030, the opening lever should be in the LOCK position; for PCA1150/PCA1500, LOCK should be displayed on the opening lever and UNLOCK should

- disappear).
4. Perform the demagnetization operation on the waveform measurement instrument.
 5. Perform the zero adjustment operation on the waveform measurement instrument to adjust the trace to the zero position.

NOTE

For PCA1030/PCA2030, if zero adjustment cannot be achieved through the waveform measurement instrument, try to use the coarse adjustment trimmer to adjust the trace to within the available zero adjustment range of the waveform measurement instrument.

While turning the coarse adjustment trimmer, do not subject it to a thrust. Doing so may cause the trimmer to come off. To turn the trimmer, use a slotted screwdriver whose flat blade is made of non-conductive materials (such as ceramic), 0.4 mm in thickness, 1.8 mm in width, and 10 mm or longer in length.

Measurement Procedure

1. Check and ensure that the system is safe and the preparations described in the preceding section have been ready.
2. Open the current sensor by pushing the opening lever in the arrow direction shown in the figure below (for PCA1030/PCA2030, the opening lever should be in the OPEN position; for PCA1150/PCA1500, UNLOCK should be displayed on the opening lever and LOCK should disappear).

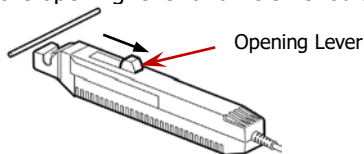

3. Adjust the current sensor to make its current direction indicator align with the actual current direction in the conductor. Clamp the sensor head around the conductor to be measured and put it in the center of the sensor head.
4. Lock the current sensor by pushing the opening lever in the arrow direction shown in the figure below (for PCA1030/PCA2030, the opening

lever should be in the LOCK position; for PCA1150/PCA1500, push the opening lever until LOCK is displayed and UNLOCK disappears).

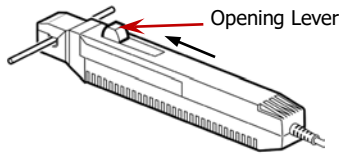

- It is now possible to monitor the current waveform. The output gain is 0.1 V/A for PCA1030/PCA2030 and 0.01 V/A for PCA1150/PCA1500. The current sensitivity can be derived from the voltage sensitivity of the waveform measurement instrument. For example, for PCA1030, if the voltage sensitivity is 10 mV/div, then the current sensitivity is $(10 \text{ mV/div}) / (0.1 \text{ V/A}) = 100 \text{ mA/div}$.

NOTE

The current consumption of the current probe depends on the current to be measured. The figure below shows the relation curve between the output current and current consumption.

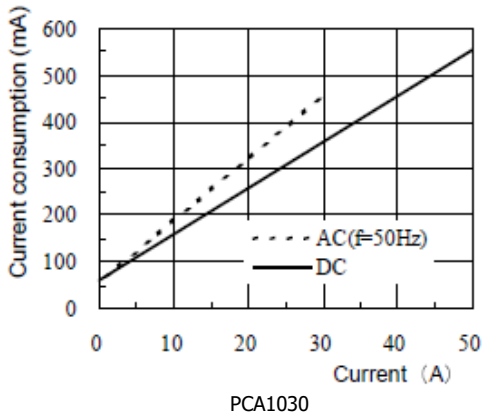

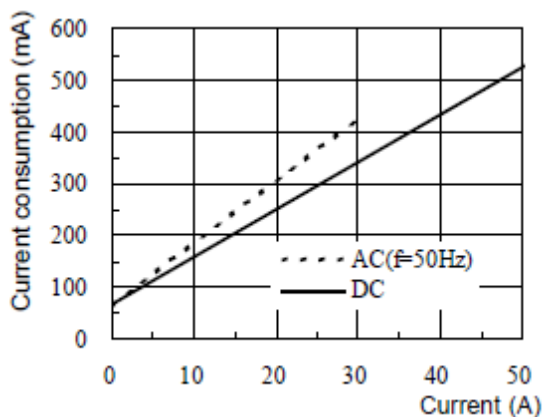

PCA2030

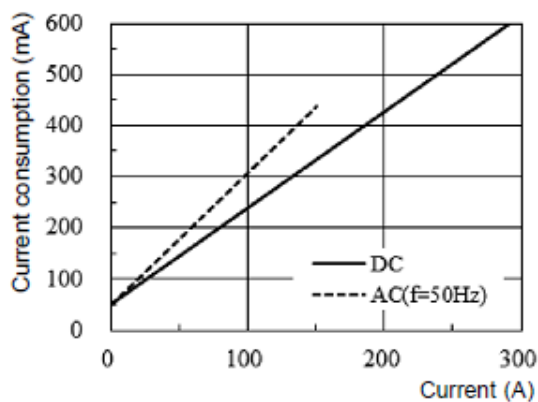

PCA1150

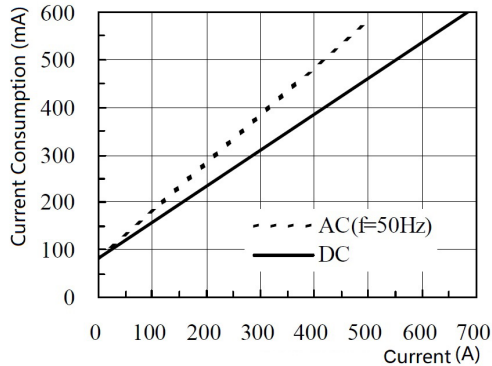

PCA1500

Note: The current consumption is the algebraic sum of the positive and negative current consumption.

Precautions for Measurement

⚠ CAUTION

1. The maximum continuous input range is based on the heat that is internally generated during the measurement. Never input current in excess of this level. Exceeding the rated level may result in damage to the probe.
2. The device may sustain damage from self-heating even at current levels that are lower than the maximum current value defined by the maximum rated current.
The maximum rated current is a recommended value that assumes sine-wave input under standard conditions. Self-heating may increase if the ambient temperature increases or the measurement current waveform contains other frequency components. Refer to **Appendix 2 Relation between Max Input Current and Frequency**.
3. If excess current is input, generated heat activates a built-in safety function that blocks normal output. If this happens, remove the input immediately (remove the sensor from the conductor being measured, or reduce the input current to zero). Wait until the sensor has had sufficient time to cool before resuming operation.

4. Heating generated during measurement of current with a frequency of 1 kHz or higher is mainly attributed to the self-heating of the sensor head. In this case, the built-in safety function will not be activated. Be careful to avoid accidents, such as a burn by heat, short-circuit, and damage to the sensor.
5. Even if the input current does not exceed the rated continuous maximum, continuous input for an extended period of time may activate the safety circuit to prevent damage resulting from heating of the sensor.
6. At a high ambient temperature, the built-in safety circuit may be activated even if the input current is below the rated continuous maximum.
7. Continuous input of current exceeding the rated maximum or repeated activation of the safety function may result in damage to the device.
8. The maximum input range is indicated by the **Maximum Continuous Input Range**. It is also indicated by another product specification **Maximum Peak Current Value**. Make sure that the input does not exceed the continuous maximum input range in rms.
9. Do not place any unclamped conductor with a current of a frequency of 10 kHz or higher near the sensor head, as shown in the following figure, as current flow in the conductor nearby may cause the temperature of the sensor head increase, leading to damage to the sensor.

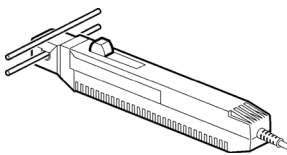

PCA1030/PCA2030

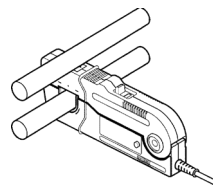

PCA1150/PCA1500

10. When opening the sensor head of the probe, be sure to operate with the opening lever. For PCA1030/PCA2030, if an upper core is forced to open while the sensor head is locked, the open-close mechanism can be damaged.

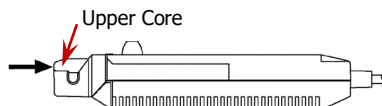

NOTE

1. Immediately after powering on, this device may be subject to an appreciable offset drift due to the effect of self-heating. To counteract this, allow the device to warm up for about 30 minutes before carrying out measurement.
2. When performing continuous measurements, it is necessary to be aware that the zero offset voltage will drift due to the impact of some factors such as the changes of the ambient temperature.
3. Under certain circumstances, oscillation may occur if the output connector is connected to the waveform measurement instrument that has been powered on. This does not indicate a malfunction. Oscillation can be stopped and operation restored to normal by opening and closing the clamp.
4. Depending on the amplitude and frequency of the current being measured, the sensor head may emit a resonant sound. This sound may also occur during demagnetizing operation, but it does not represent a malfunction (device failure).
5. If foreign matter becomes adhered to the gear mating surface of the sensor head, a slight gap will appear between its upper and lower layer. In this case, a resonant sound will be produced from the sensor head. Therefore, any foreign matter on the gear mating surface of the sensor head should be removed by using the cleaning method described in this manual.
6. An increase in the volume of the resonant sound during use may indicate that the gap between the upper and lower layer has increased. Since the sensor characteristics may change, it is recommended to calibrate the device.
7. Perform the demagnetization operation on the waveform measurement instrument will generate a demagnetized waveform. Although the waveform may be asymmetry with respect to the zero-volt line, it does not indicate a malfunction.
8. The reading may be affected by the position within the clamp aperture of the conductor being measured. The conductor should be in the center of the clamp aperture.

9. When carrying out measurement, make sure that the sensor head is locked (for PCA1030/PCA2030, the opening lever should be in the LOCK position; for PCA1150/PCA1500, slide the opening lever until the "UNLOCK" indication disappears, and hold it until LOCK appears). If the sensor head is not properly closed, accurate measurement will not be possible.
10. Accurate measurement may be impossible in locations subject to strong external magnetic fields, such as transformers and high current conductors, or in locations subject to strong external electric fields, such as radio transmission equipment.
11. At high frequencies, common mode noise may affect measurements taken on the high voltage side of the circuit. If this occurs, reduce the frequency range of the waveform measurement instrument or clamp onto the low-voltage side of the circuit, as appropriate.

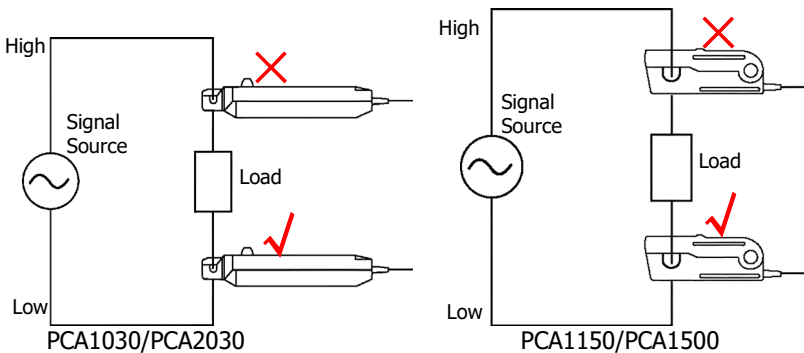

Specifications

When the device works for at least 30 minutes at 23°C±5°C, the following specifications can be guaranteed.

PCA1030/PCA2030

Bandwidth	PCA1030: DC to 50 MHz (-3 dB), refer to Appendix 1 Amplitude-Frequency Characteristics (PCA1030) PCA2030: DC to 100 MHz (-3 dB), refer to Appendix 1 Amplitude-Frequency Characteristics (PCA2030)
Rise Time	PCA1030: ≤7 ns PCA2030: ≤3.5 ns
Maximum Continuous Input Range	30Arms, refer to Appendix 2 Relation between Max Input Current and Frequency (PCA1030/PCA2030)
Maximum Peak Current Value	Non-continuous 50A peak
Gain	0.1V/A
Amplitude Accuracy	±1.0%rdg±1 mV, ≤30 Arms ±2.0%rdg, ≤50A peak (DC, and 45 to 66 Hz, input within continuous maximum input range)
Noise	≤2.5 mArms (for 20MHz band waveform measurement instrument)
Input Impedance	Refer to Appendix 3 Input Impedance (Typical) (PCA1030/PCA2030)
Temperature Coefficient for Sensitivity	≤±2% (during input of 50 Hz, 30 Arms within the range of 0°C-40°C)
Maximum Rated Power	8.5 VA
Operating Temperature and Humidity Range	0°C to 40°C, ≤80% RH (no condensation)
Storage Temperature and Humidity Range	-10°C to 50°C, ≤80% RH (no condensation)
Location for Use	Indoor, altitude up to 2,000 m, Pollution Degree 2

Effect of External Magnetic Fields	PCA1030: ≤ 20 mA (DC and 60 Hz, Magnetic field of 400 A/m) PCA2030: ≤ 5 mA (DC and 60 Hz, Magnetic field of 400 A/m)
Diameter of Conductor Available for Measurement	5 mm
Conductor Available for Measurement	Insulated conductor
Guaranteed Accuracy Period	1 year (opening/closing up to 10,000 times)
Cable Length	Sensor cable: approx. 1.5m
External Dimension	Sensor: approx. 175W \times 18H \times 40D (mm) (excluding protrusions) Terminator: approx. 27H \times 55W \times 18D (mm)
Weight	PCA1030: approx. 230 g PCA2030: approx. 240 g
Accessories	User Guide, Probe Case
Safety	EN61010
EMC	EN61326

PCA1150

Bandwidth	DC to 10 MHz (-3 dB), refer to Appendix 1 Amplitude-Frequency Characteristics (PCA1150)
Rise Time	≤ 35 ns
Maximum Continuous Input Range	150 A, refer to Appendix 2 Relation between Max Input Current and Frequency (PCA1150)
Maximum Peak Current Value	300A peak, non-continuous 500A peak, pulse width ≤ 30 μ s
Gain	0.01V/A
Amplitude Accuracy	$\pm 1.0\%$ rdg ± 1 mV, ≤ 150 A $\pm 2.0\%$ rdg, 150 A to 300 A peak (DC, and 45 Hz to 66 Hz)
Noise	≤ 25 mArms (for 20 MHz band waveform measurement instrument)
Input Impedance	Refer to Appendix 3 Input Impedance

RIGOL

	(Typical) (PCA1150)
Temperature Coefficient for Sensitivity	≤±2% (input: 55 Hz, 150 A, within a range of 0°C-40°C)
Maximum Rated Power	8.5 VA
Operating Temperature and Humidity Range	0°C to 40°C, ≤80% RH (no condensation)
Storage Temperature and Humidity Range	-10°C to 50°C, ≤80% RH (no condensation)
Location for Use	Indoor, altitude up to 2,000 m, Pollution Degree 2
Guaranteed Accuracy Period	1 year (opening/closing up to 10,000 times)
Effect of External Magnetic Field	≤150 mA (in a DC or 60 Hz, 400 A/m magnetic field)
Diameter of Conductor Available for Measurement	20 mm
Conductor Available for Measurement	Insulated conductor
Cable Length	Sensor cable: approx. 2 m
External Dimension	Sensor: approx. 176W X 69H X 27D (mm) Terminator: approx. 27H X 55W X 18D (mm)
Weight	Approx. 500 g
Accessories	User Guide, Probe Case
Safety	EN61010
EMC	EN61326

PCA1500

Bandwidth	DC to 2 MHz (-3 dB), refer to Appendix 1 Amplitude-frequency Characteristics (PCA1500)
Rise Time	≤175 ns
Maximum Continuous Input Range	500 Arms, refer to Appendix 2 Relation between Max Input Current and Frequency (PCA1500)

Maximum Peak Current Value	700A peak, non-continuous
Gain	0.01 V/A
Amplitude Accuracy	$\pm 1.0\%$ rdg ± 5 mV, ≤ 500 Arms $\pm 2.0\%$ rdg, ≤ 700 A peak (DC, 45 Hz to 66 Hz)
Noise	≤ 25 mArms (for BW 20 MHz waveform measuring instrument)
Input Impedance	Refer to Appendix 3 Input Impedance (Typical) (PCA1500)
Temperature Coefficient for Sensitivity	$\leq \pm 2\%$ (during input of 50 Hz, 500 Arms within range of 0°C to 40°C)
Maximum Rated Power	7.2 VA (within maximum continuous input range)
Operating Temperature and Humidity Range	0°C to 40°C, $\leq 80\%$ RH (no condensation)
Storage Temperature and Humidity Range	-10°C to +50°C, $\leq 80\%$ RH (no condensation)
Location for Use	Indoor, altitude up to 2,000 m, Pollution Degree 2
Period of Guaranteed Accuracy	1 year (opening/closing up to 10,000 times)
Effect of External Magnetic Fields	≤ 800 mA (in a DC or 60 Hz, 400 A/m magnetic field)
Diameter of Measurable Conductor	20 mm
Measurable Conductor	Insulated conductor
Cable Length	Sensor cable: approx. 2 m
External Dimension	Sensor: approx. 176W X 69H X 27D (mm) Terminator: approx. 27H X 55W X 18D (mm)
Mass	Approx. 520g
Accessories	User Guide, Probe Case
Safety	EN61010
EMC	EN61326

Appendix

Appendix 1 Amplitude-Frequency Characteristics

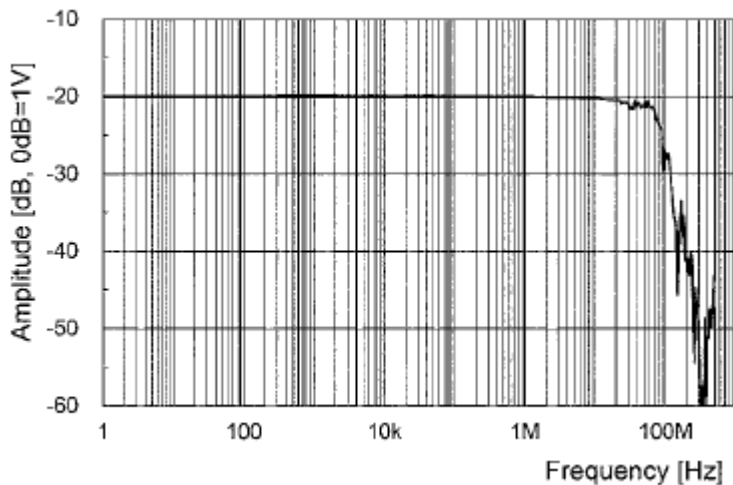

PCA1030

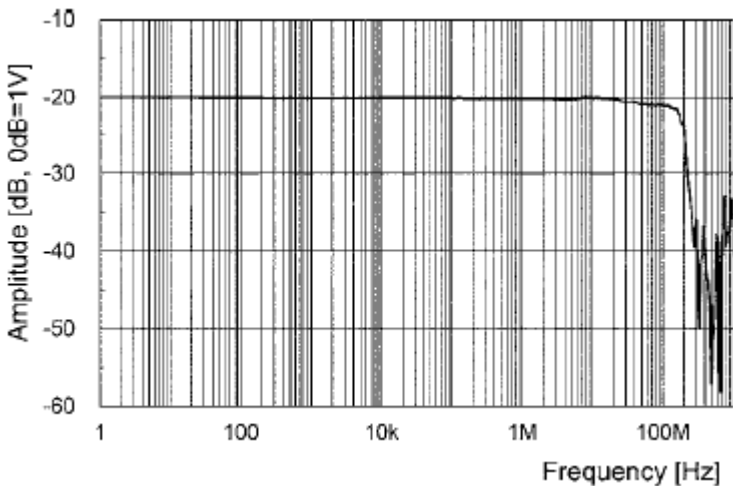

PCA2030

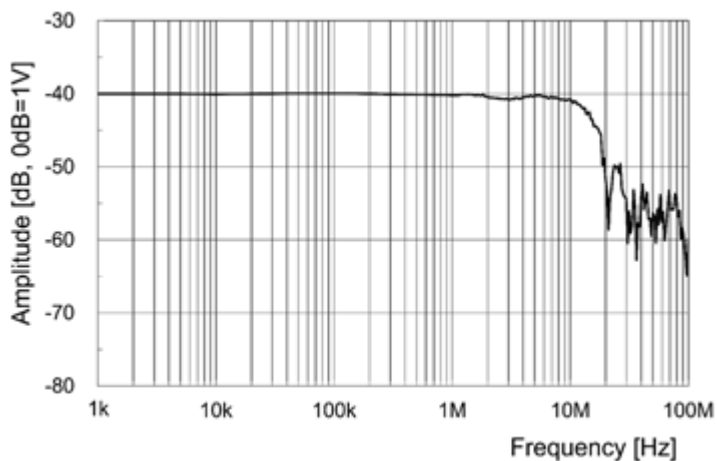
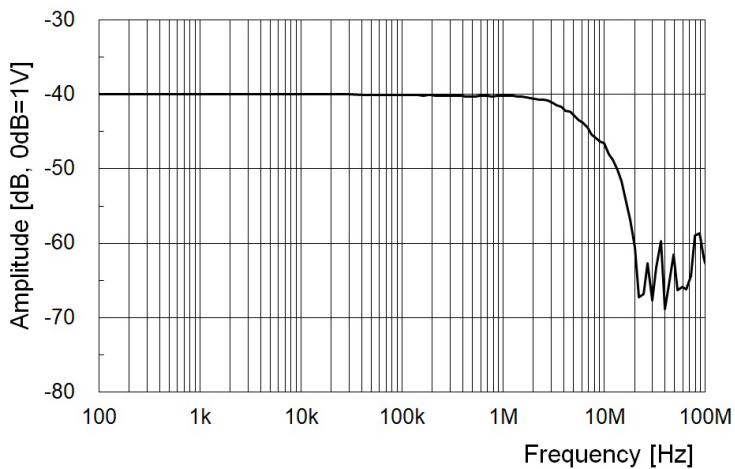
**PCA1150****PCA1500**

Appendix 2 Relation between Max Input Current and Frequency

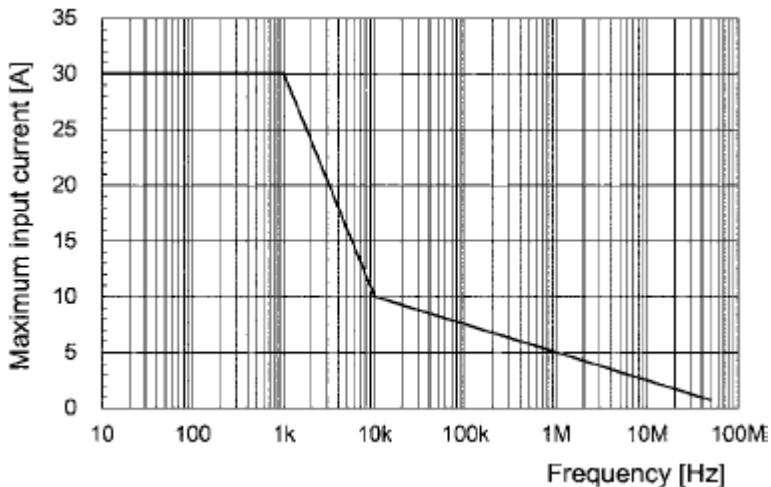
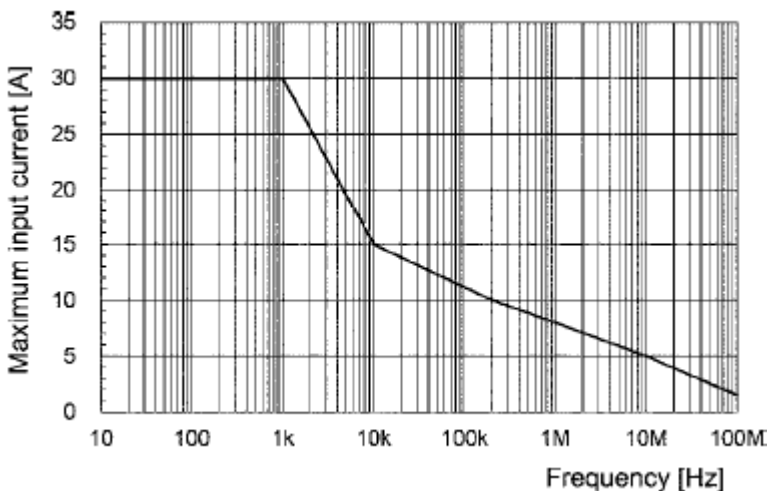
**PCA1030****PCA2030**

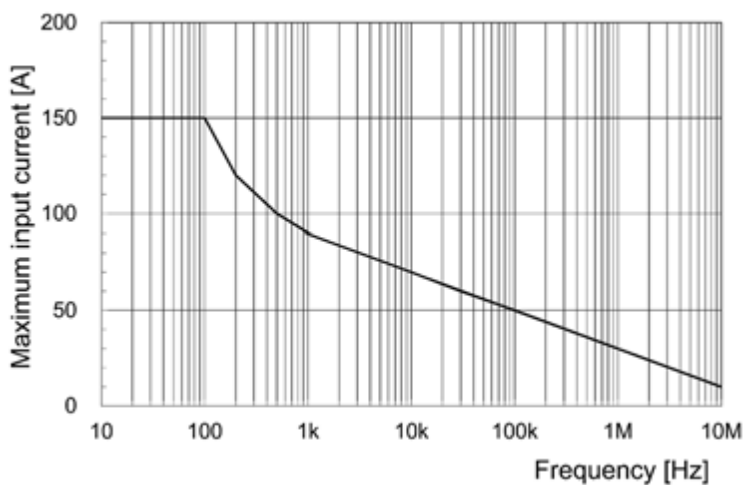
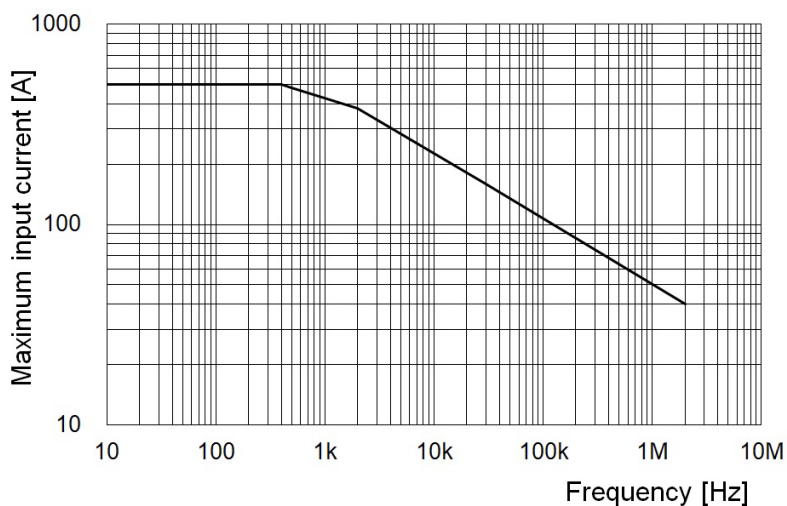
**PCA1150****PCA1500**

Appendix 3 Input Impedance (Typical)

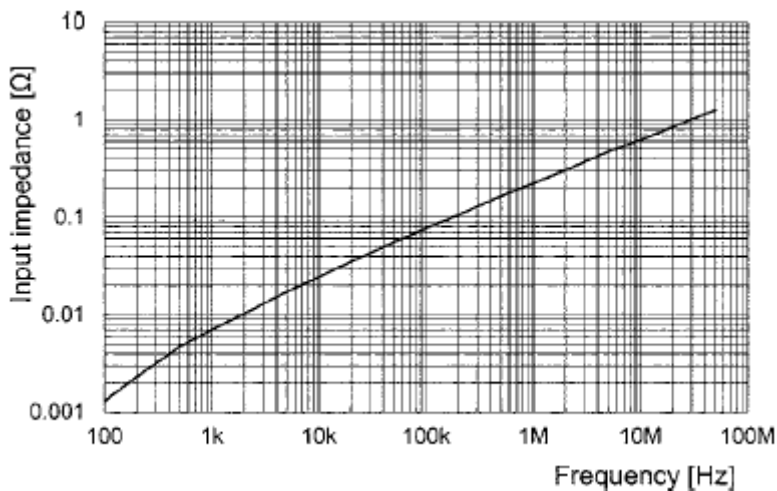

PCA1030

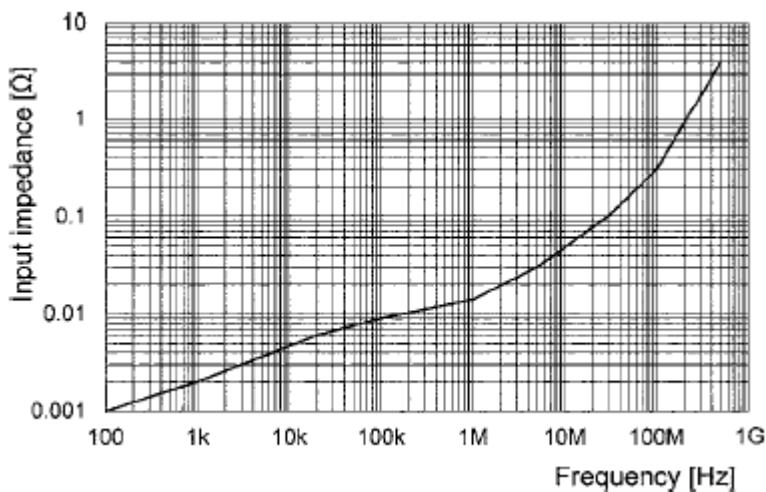

PCA2030

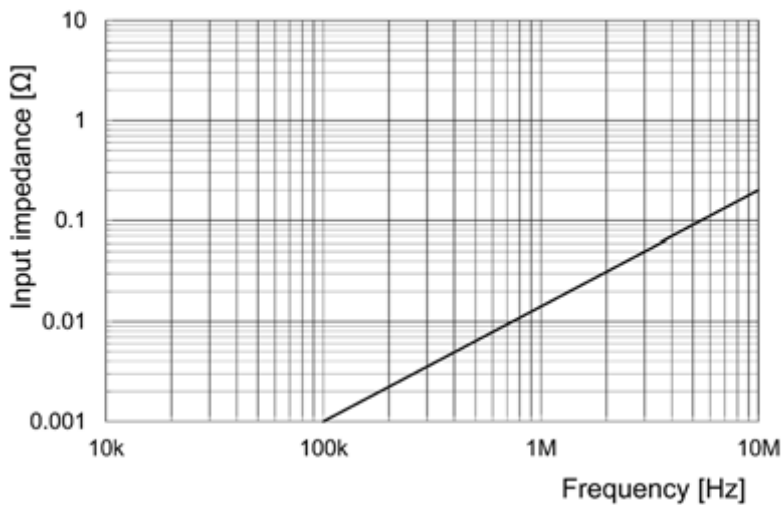
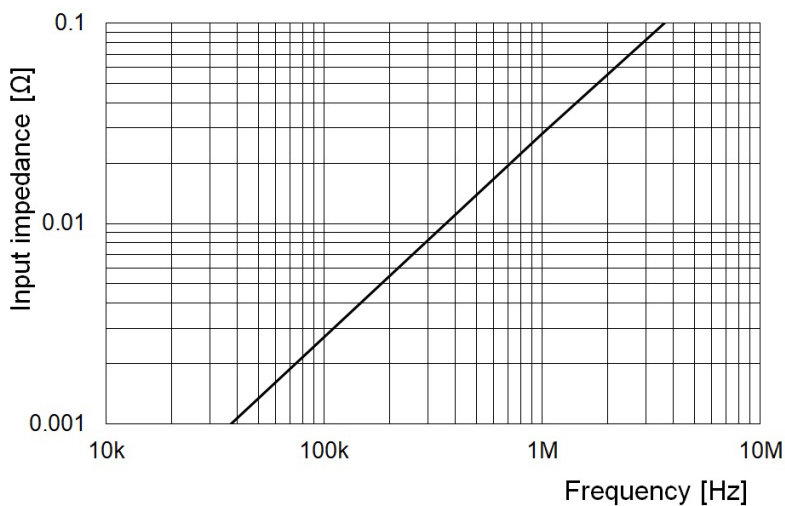
**PCA1150****PCA1500**